

KIT  
BANHO<sup>®</sup>

KLOSS<sup>®</sup>

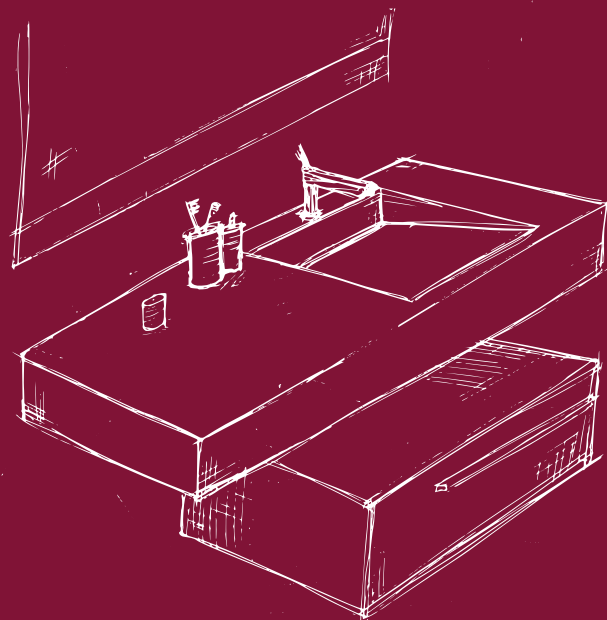
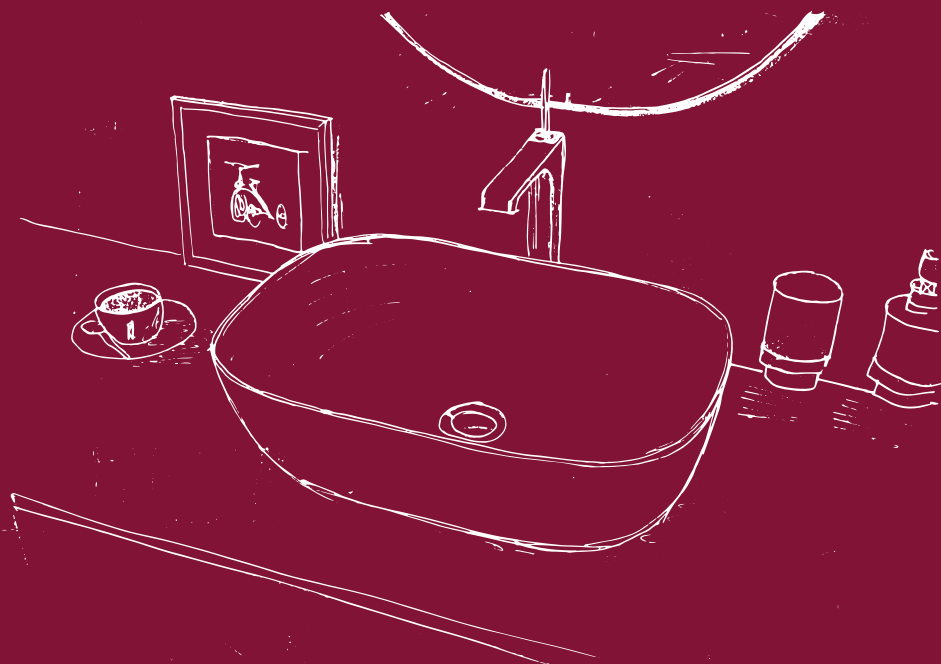
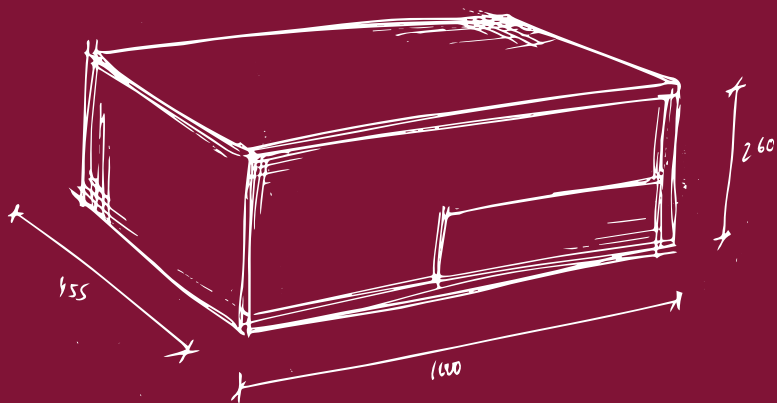

**KIT  
BA  
NHO®**

[www.kitbanho.com](http://www.kitbanho.com)

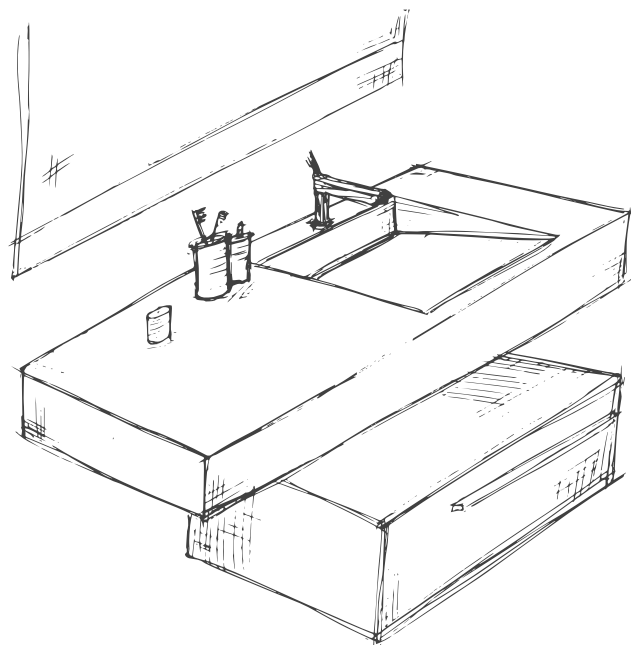
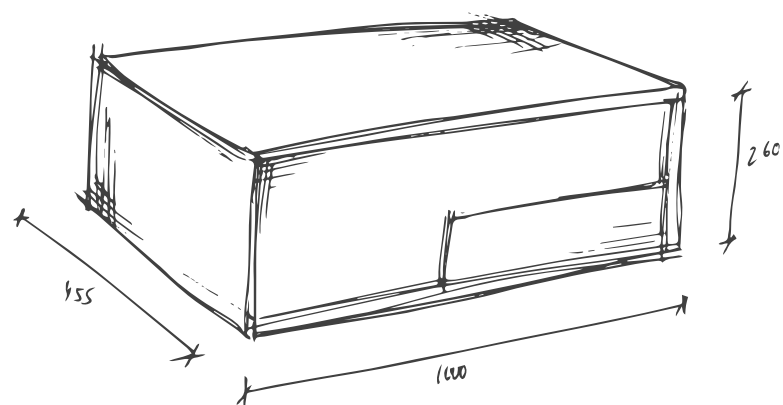

---

murais <b>KLOSS STD</b>	004
murais <b>KLOSS - CUBAS ESPECIAIS</b>	012
murais <b>KLOSS HILL</b>	020
<b>MÓDULOS DE GAVETA</b>	028
estrutura <b>KLOSS STD</b>	042
<b>LAVATÓRIOS DE POUSAR</b>	046
<b>TAMPOS</b>	072
<b>ACABAMENTOS</b>	076

---

murais  
**KLOSS STD**

KIT  
BA  
NHO® | **KLOSS®**







\_ espelho ancara , preto  
\_ mural KLOSS STD 140 SD  
\_ zurique alt.26 140 DD + tampo , branco / carvalho

006

007



008

- \_ camarino kloss 140 , héracles
- \_ mural KLOSS STD 140 D
- \_ pompeia alt.26 140 DD + tampo , branco

KIT  
BANHO® | KLOSS®







\_ mural KLOSS STD 120 S  
\_ zurique alt.26 100 S + tampo , carvalho cinza / branco

## murais KLOSS STD

Alt. 10 - profundidade 45,5

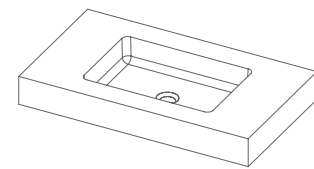

80 S\_ sob consulta  
100 S\_ sob consulta  
120 S\_ sob consulta  
140 S\_ sob consulta

obs:  
mur. 80 \_cuba 45  
mur. 100/120/140 \_cuba 55

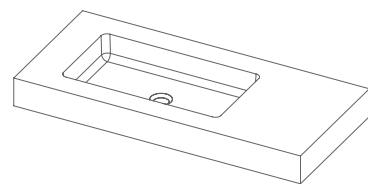

100 SE\_ sob consulta  
120 SE\_ sob consulta  
140 SE\_ sob consulta

obs:  
mur. 100/120/140 \_cuba 55

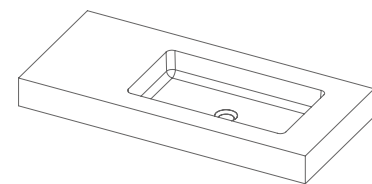

100 SD\_ sob consulta  
120 SD\_ sob consulta  
140 SD\_ sob consulta

obs:  
mur. 100/120/140 \_cuba 55

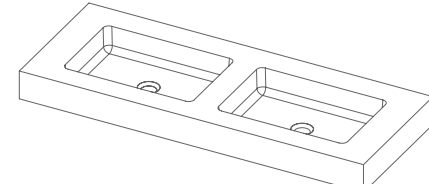

120 D\_ sob consulta  
140 D\_ sob consulta

obs:  
mur. 120/140 \_cuba 45



acabamentos:  
- branco brilho / branco mate

obs.:  
- todas os murais têm a possibilidade de ter furo para a torneira.  
- c/ sistema de fixação na parede incluído.  
- stock permanente (excepto cantos arredondados).

- não é possível alterar medidas técnicas dos murais, nem posição das cubas.

## Medidas técnicas - murais KLOSS STD alt.10

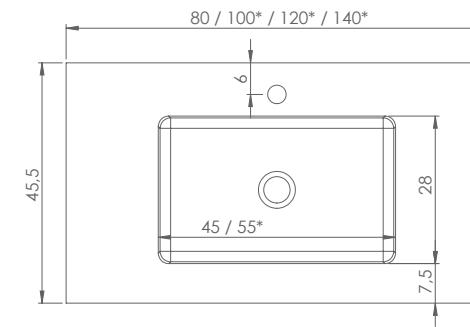

ref.: SIMPLES

obs.: furo de torneira opcional.  
profundidade da cuba 8,5cm.

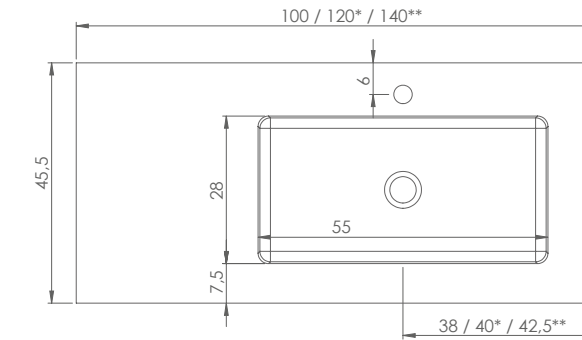

ref.: DIREITOS

obs.: furo de torneira opcional.  
profundidade da cuba 8,5cm.

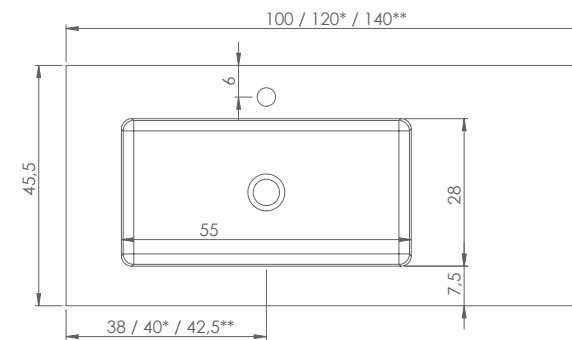

ref.: ESQUERDOS

obs.: furo de torneira opcional.  
profundidade da cuba 8,5cm.

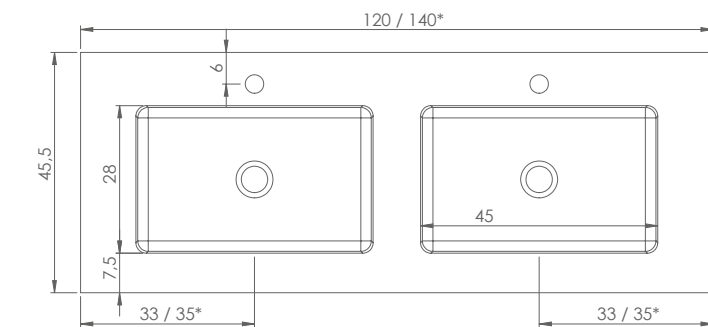

ref.: DUPLO

obs.: furo de torneira opcional.  
profundidade da cuba 8,5cm.

Mais imagens  
do produto



Desenhos técnicos



murais  
**KLOSS** \_cubas especiais

KIT  
BANHO® | **KLOSS®**



\_ mural KLOSS 180 D \_NILO  
\_ astro alt.10 120 , branco







\_ mural KLOSS \_ARES  
\_ granada alt.26 80 + tampo , azul petróleo



\_ mural KLOSS \_CLARK  
\_ odessa alt.26 + tampo , branco  
\_ espelho nápoles



015

014



\_ mural KLOSS \_ARES



\_ mural KLOSS \_BORO



\_ mural KLOSS \_MITO

KIT  
BA  
NHO® | KLOSS®

016



\_ mural KLOSS \_BORO 80

**KIT  
BANHO** | **KLOSS**<sup>®</sup>

017



\_ mural KLOSS \_BORO 80  
 \_ berna alt.26 + tampo , preto / branco  
 \_ espelho astro





\_ mural KLOSS  
\_ ancara alt.26 + tampo , tea  
\_ espelho nápoles

## murais KLOSS \_cubas diversas

Alt. 15 - profundidade especial

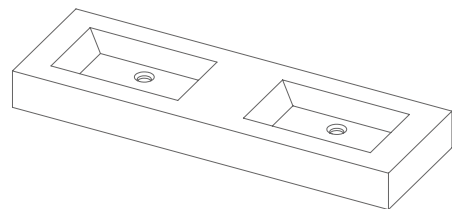
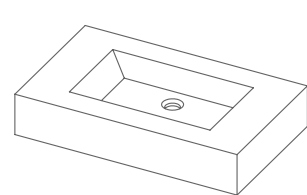

80 S\_ sob consulta  
90 S\_ sob consulta  
100 S\_ sob consulta  
110 S\_ sob consulta  
120 S\_ sob consulta  
130 S\_ sob consulta  
140 S\_ sob consulta  
150 S\_ sob consulta  
160 S\_ sob consulta  
170 S\_ sob consulta  
180 S\_ sob consulta  
190 S\_ sob consulta  
200 S\_ sob consulta

120 D\_ sob consulta  
130 D\_ sob consulta  
140 D\_ sob consulta  
150 D\_ sob consulta  
160 D\_ sob consulta  
170 D\_ sob consulta  
180 D\_ sob consulta  
190 D\_ sob consulta  
200 D\_ sob consulta

acabamentos:  
- branco brilho / branco mate  
- preto brilho

obs.:  
- todos os murais tem a possibilidade de ter furo para a torneira.  
- possibilidade de toalheiro.  
- em murais entre paredes é possível fazer ao milímetro.  
- c/ sistema de fixação na parede incluído.  
- possibilidade de posicionar a cuba onde desejar.

- prazo de entrega de 4 a 5 semanas.



Mais imagens  
do produto



## Medidas técnicas - murais KLOSS \_cubas diversas

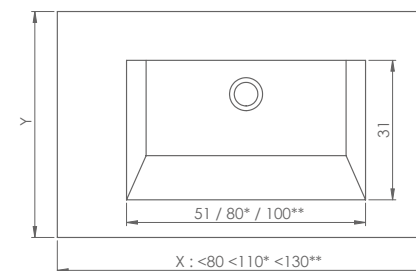

### BORO 51 / 80 / 100

- profundidade mínima c/ torneira 455 mm.
- profundidade mínima s/ torneira 410 mm.
- 1 cuba, medidas de 80cm a 200cm.
- 2 cubas, medidas de 130cm a 200cm.
- altura da cuba 10,5cm.

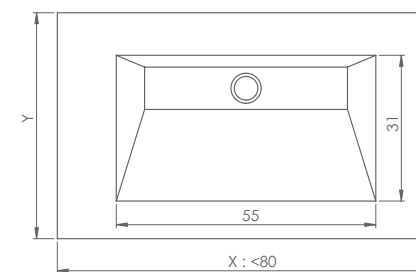

### NILO 55

- profundidade mínima c/ torneira 450 mm.
- profundidade mínima s/ torneira 410 mm.
- 1 cuba, medidas de 80cm a 200cm.
- 2 cubas, medidas de 140cm a 200cm.
- altura da cuba 10,5cm.

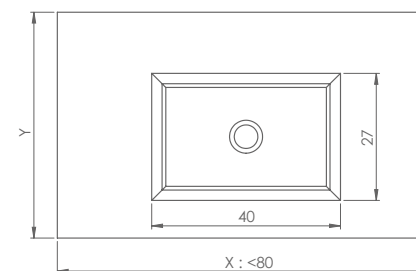

### MITO 40

- profundidade mínima c/ torneira 415 mm.
- profundidade mínima s/ torneira 380 mm.
- 1 cuba, medidas de 80cm a 200cm.
- 2 cubas, medidas de 120cm a 200cm.
- altura da cuba 11cm.

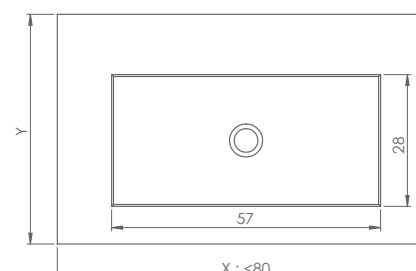

### ARES 57

- profundidade mínima c/ torneira 430 mm.
- profundidade mínima s/ torneira 400 mm.
- 1 cuba, medidas de 80cm a 200cm.
- 2 cubas, medidas de 140cm a 200cm.
- altura da cuba 8cm.

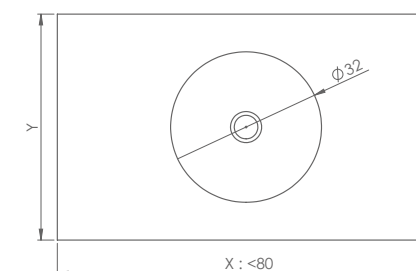

### CLARK 32

- profundidade mínima c/ torneira 440 mm.
- profundidade mínima s/ torneira 410 mm.
- 1 cuba, medidas de 80cm a 200cm.
- 2 cubas, medidas de 120cm a 200cm.
- altura da cuba 15cm.

KIT  
BANHO®  
KLOSS®

Desenhos técnicos



murais  
**KLOSS HILL**

KIT  
BA  
NHO® | KLOSS®



\_ mural KLOSS \_HILL  
\_ astro alt.25 , nogueira



\_ mural KLOSS \_HILL  
\_ astro alt.25 , nogueira

020

021

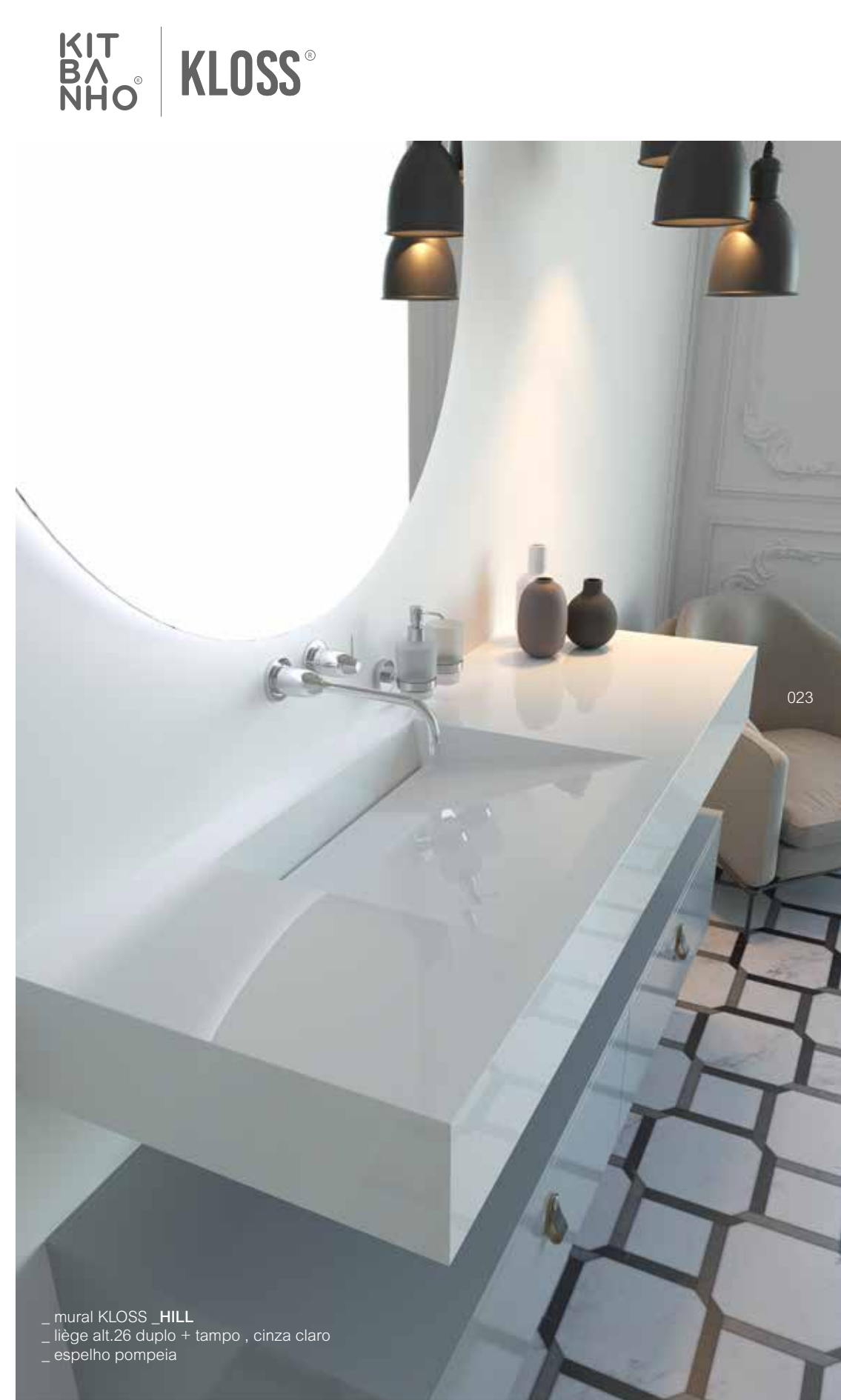

\_ mural KLOSS \_HILL  
\_ liège alt.26 duplo + tampo , cinza claro  
\_ espelho pompeia

022

023





024

\_ mural KLOSS \_HILL  
 \_ berna alt.26 + tampo , hérules / branco  
 \_ espelho mira vertical

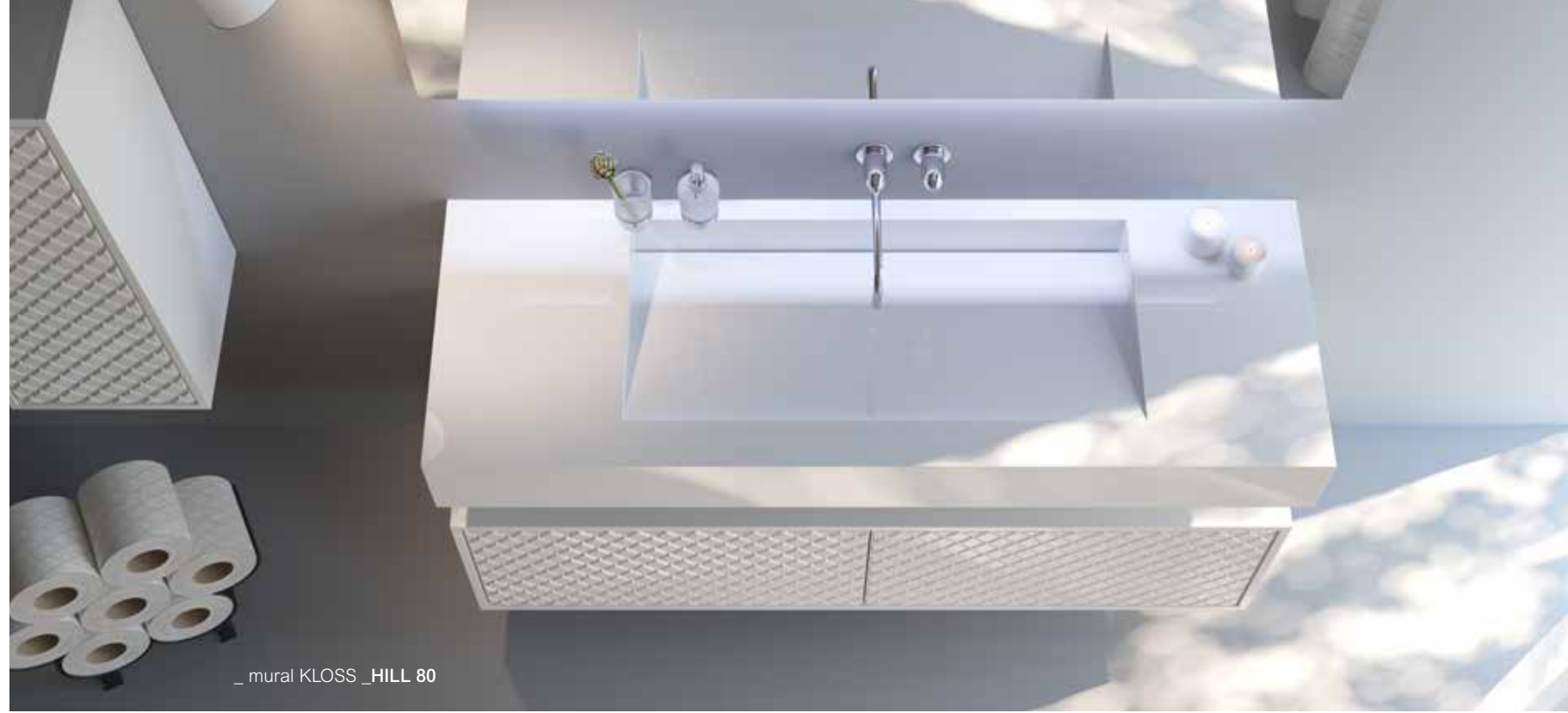

\_ mural KLOSS \_HILL 80

KIT  
 BANHO® | KLOSS®



025

\_ mural KLOSS \_HILL

## murais KLOSS HILL

Alt. 15 - profundidade especial

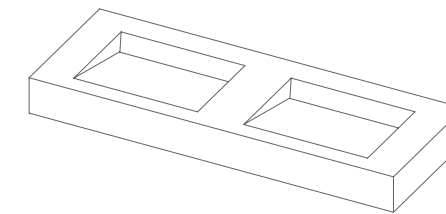
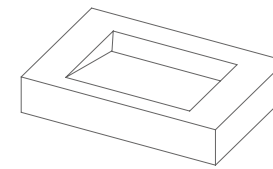

acabamentos:  
- branco brilho / branco mate  
- preto brilho

obs.:  
- todos os murais tem a possibilidade de ter furo para a torneira.  
- possibilidade de toalheiro.  
- em murais entre paredes é possível fazer ao milímetro.  
- c/ sistema de fixação na parede incluído.  
- possibilidade de posicionar a cuba onde desejar.

- prazo de entrega de 4 a 5 semanas.

80 S\_ sob consulta  
90 S\_ sob consulta  
100 S\_ sob consulta  
110 S\_ sob consulta  
120 S\_ sob consulta  
130 S\_ sob consulta  
140 S\_ sob consulta  
150 S\_ sob consulta  
160 S\_ sob consulta  
170 S\_ sob consulta  
180 S\_ sob consulta  
190 S\_ sob consulta  
200 S\_ sob consulta

140 D\_ sob consulta  
150 D\_ sob consulta  
160 D\_ sob consulta  
170 D\_ sob consulta  
180 D\_ sob consulta  
190 D\_ sob consulta  
200 D\_ sob consulta

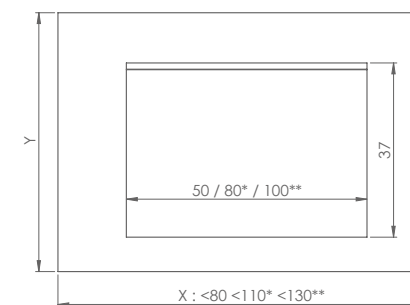

### HILL 50 / 80 / 100

- profundidade mínima c/ torneira 500 mm.
- profundidade mínima s/ torneira 455 mm.
- 1 cuba, medidas de 80cm a 200cm.
- 2 cuba, medidas de 130cm a 200cm.
- altura da cuba 10cm.

\_ mural KLOSS\_HILL  
\_ nápoles alt.36 + tampo , branco  
\_ espelho astro

KIT  
BA  
NHO®  
KLOSS®

A estes preços acresce IVA à taxa em vigor.

Mais imagens  
do produto



Manual técnico



# MÓDULOS DE GAVETA

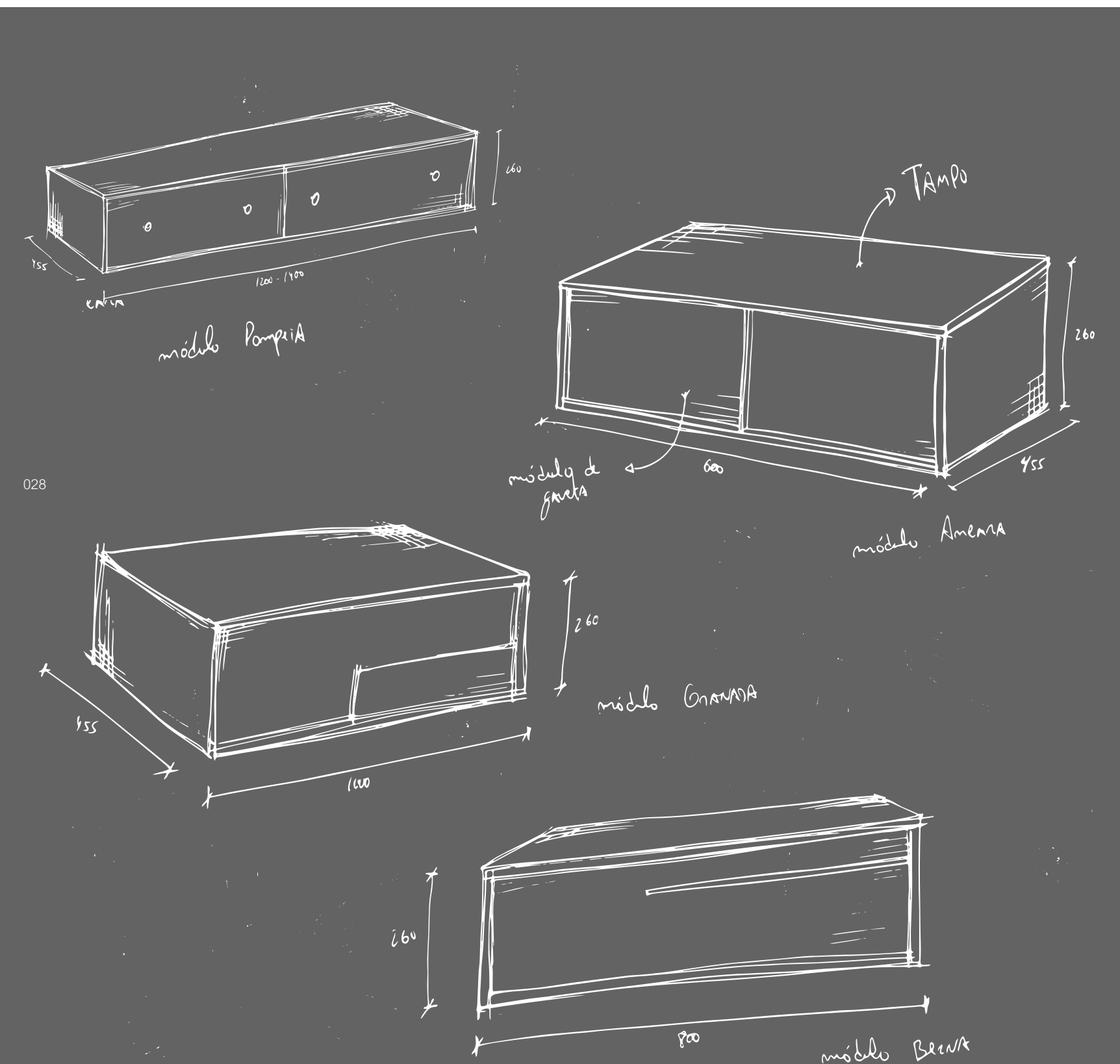

## modelo NÁPOLES

Alt. 36 - profundidade 45,5

preço base sem tampo

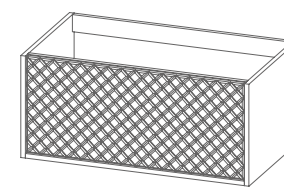

80 S\_ sob consulta  
100 S\_ sob consulta  
120 S\_ sob consulta

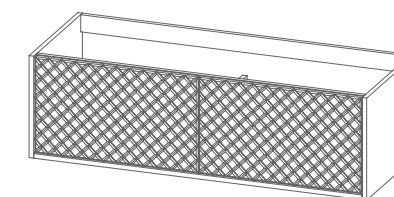

120 DD\_ sob consulta  
140 DD\_ sob consulta



obs:  
móvel 80/100/120S \_1 gavetão  
móvel 120DD/140DD \_2 gavetões

Tampos - profundidade 45,5

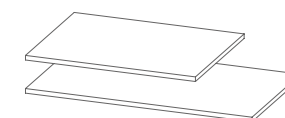

80\_ sob consulta  
100\_ sob consulta  
120\_ sob consulta  
140\_ sob consulta

## Acabamentos

lacados . categoria 01

branco brilho	preço base do móvel sem tampo.
------------------	-----------------------------------

obs:  
neste modelo não é possível utilizar  
melaminas ou folheados.

nota:  
possibilidade de combinar acabamentos,  
tendo em conta os respetivos acréscimos  
por cada categoria.

ex: corpo branco + frente lacado cor =  
= acréscimo categoria 2

lacados brilho / mate . categoria 02

branco mate 01	02	03	04
05	06	07	08
09			

acabamentos pág. 076

Mais imagens  
do produto catálogo  
DESIGN COLLECTION pág. 20



Manual técnico



kitbanho.com/napoles



# modelo ANCARA

Alt. 26 - profundidade 45,5

preço base sem tampo

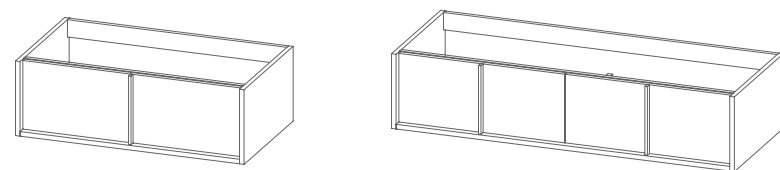

60 S\_ sob consulta  
80 S\_ sob consulta  
100 S\_ sob consulta  
120 S\_ sob consulta

120 DD\_ sob consulta  
140 DD\_ sob consulta

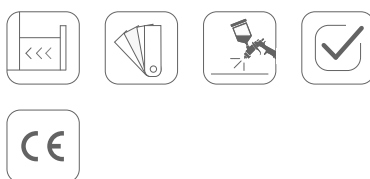

obs:  
móvel 60/80/100/120S \_1 gaveta  
móvel 120DD/140DD \_2 gavetas

Tampos - profundidade 45,5

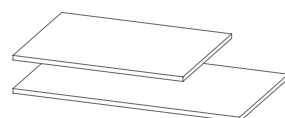

60\_ 65,00 €  
80\_ 75,00 €  
100\_ 90,00 €  
120\_ 105,00 €  
140\_ 115,00 €

# modelo ODESSA tipo \_02

Alt. 26 - profundidade 45,5

preço base sem tampo

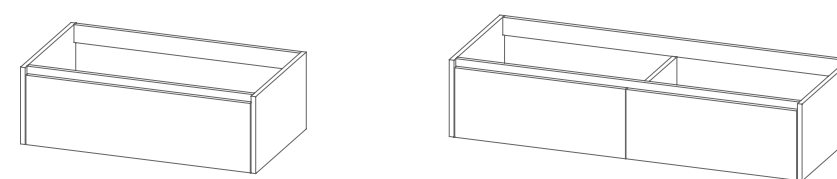

60 S\_ sob consulta  
80 S\_ sob consulta  
100 S\_ sob consulta  
120 S\_ sob consulta

120 DD\_ sob consulta  
140 DD\_ sob consulta

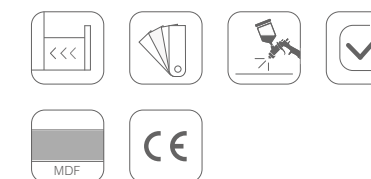

obs:  
móvel 60/80/100/120S \_1 gaveta  
móvel 120DD/140DD \_2 gavetas  
gaveta abertura superior

Tampos - profundidade 45,5

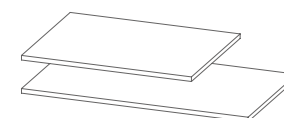

60\_ sob consulta  
80\_ sob consulta  
100\_ sob consulta  
120\_ sob consulta  
140\_ sob consulta

## Acabamentos

lacados / melaminas . categoria 01

lacados brilho / mate . categoria 02

folheados . categoria 03

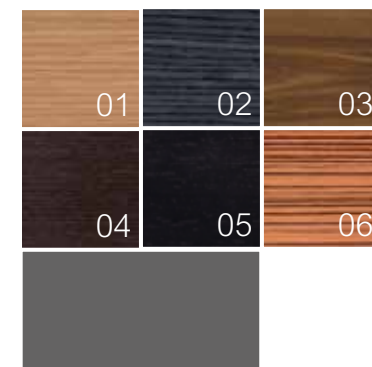
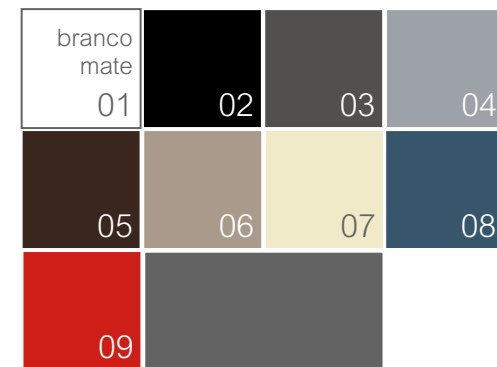

acabamentos pág. 076

nota:  
possibilidade de combinar acabamentos,  
tendo em conta os respetivos acréscimos  
por cada categoria.

ex: corpo branco + frente folha =  
= acréscimo categoria 3

Mais imagens  
do produto catálogo  
DESIGN COLLECTION pág. 30



kitbanho.com/ancara

Manual técnico



KIT  
BANHO®

A estes preços acresce IVA à taxa em vigor.

## Acabamentos

lacados / melaminas . categoria 01

lacados brilho / mate . categoria 02

folheados . categoria 03

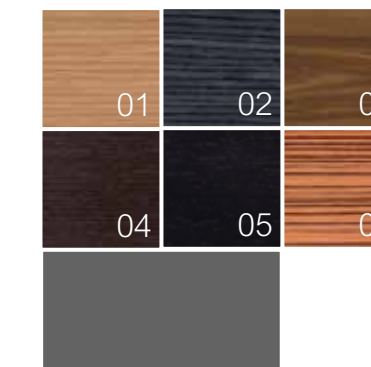
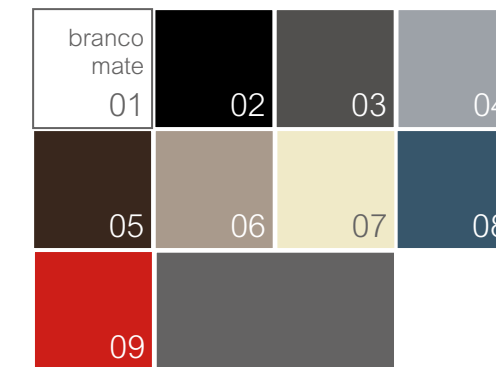

acabamentos pág. 076

nota:  
possibilidade de combinar acabamentos,  
tendo em conta os respetivos acréscimos  
por cada categoria.

ex: corpo branco + frente folha =  
= acréscimo categoria 3

Mais imagens  
do produto catálogo  
DESIGN COLLECTION pág. 44



kitbanho.com/odessa

Manual técnico



A estes preços acresce IVA à taxa em vigor.

# modelo ASTRO

Alt. 10 - profundidade 45,5

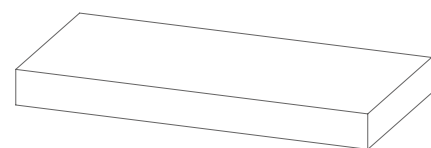

60\_ sob consulta    120\_ sob consulta  
80\_ sob consulta    140\_ sob consulta  
100\_ sob consulta    160\_ sob consulta

obs:  
c/ sistema de fixação na parede incluído.

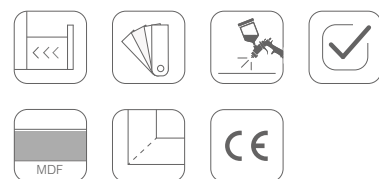

Alt. 25 - profundidade 45,5

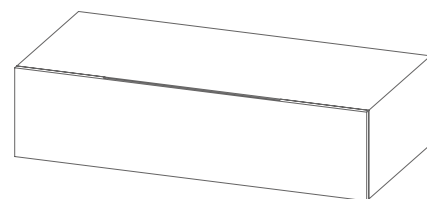

60\_ sob consulta  
70\_ sob consulta  
80\_ sob consulta  
100\_ sob consulta

obs:  
módulo 60/70/80/100 \_1 gaveta soft-close GRASS.  
não necessita de tampo.

Mais imagens  
do produto catálogo  
DESIGN COLLECTION pág. 58

kitbanho.com/astro

Manual técnico

**KIT  
BANHO®**

A estes preços acresce IVA à taxa em vigor.

# modelo ZURIQUE

Alt. 26 - profundidade 45,5

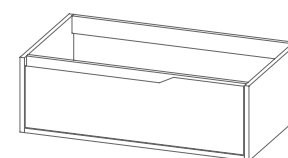

60 S\_ sob consulta  
80 S\_ sob consulta  
100 S\_ sob consulta  
120 S\_ sob consulta

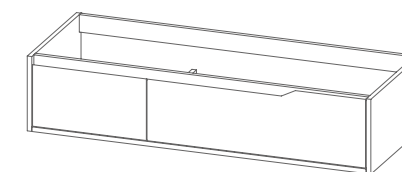

120 SD\_ sob consulta

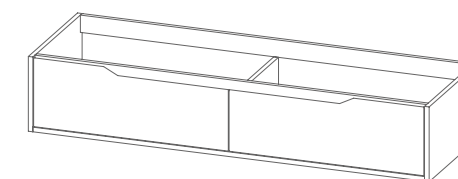

120 DD\_ sob consulta  
140 DD\_ sob consulta

obs:  
móvel 60/80/100/120S \_1 gaveta  
móvel 120SD \_2 gavetas  
móvel 120DD/140DD \_2 gavetas



Tampos - profundidade 45,5

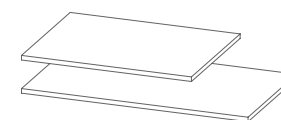

60\_ sob consulta  
80\_ sob consulta  
100\_ sob consulta  
120\_ sob consulta  
140\_ sob consulta

## Acabamentos

lacados . categoria 01

branco brilho	preço base do móvel.
------------------	----------------------

obs:  
neste modelo não é possível utilizar  
melaminas.

nota:  
possibilidade de combinar acabamentos,  
tendo em conta os respetivos acréscimos  
por cada categoria.

ex: corpo branco + frente lacado cor =  
= acréscimo categoria 2

lacados brilho / mate . categoria 02

branco mate 01	02	03	04
05	06	07	08
09			

folheados . categoria 03

01	02	03
04	05	06

acabamentos pág. 076

ex: corpo branco + frente lacado cor =  
= acréscimo categoria 2

lacados brilho / mate . categoria 02

branco mate 01	02	03	04
05	06	07	08
09			

obs:  
neste modelo não é possível utilizar  
melaminas.

nota:  
possibilidade de combinar acabamentos,  
tendo em conta os respetivos acréscimos  
por cada categoria.

Mais imagens  
do produto catálogo  
DESIGN COLLECTION pág. 68



kitbanho.com/zurique

Manual técnico



A estes preços acresce IVA à taxa em vigor.

## Acabamentos

# modelo SARA

Alt. 26 - profundidade 45,5

preço base sem tampo

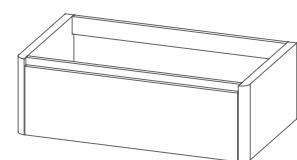

60 S\_ sob consulta  
80 S\_ sob consulta  
100 S\_ sob consulta  
120 S\_ sob consulta

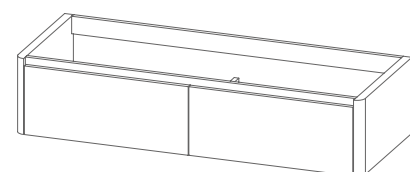

120 DD\_ sob consulta  
140 DD\_ sob consulta

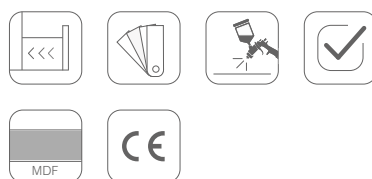

obs:  
móvel 60/80/100/120S \_1 gaveta  
móvel 120DD/140DD \_2 gavetas

Tampos - profundidade 45,5

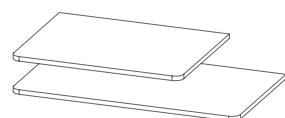

60\_ sob consulta  
80\_ sob consulta  
100\_ sob consulta  
120\_ sob consulta  
140\_ sob consulta

# modelo BERNA

Alt. 26 - profundidade 45,5

preço base sem tampo

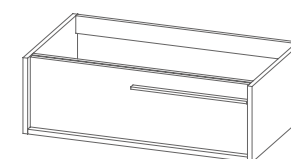

60 S\_ sob consulta  
80 S\_ sob consulta  
100 S\_ sob consulta  
120 S\_ sob consulta

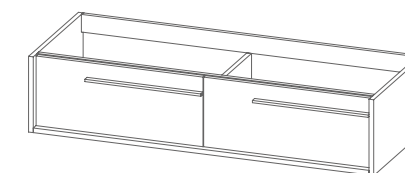

120 DD\_ sob consulta  
140 DD\_ sob consulta

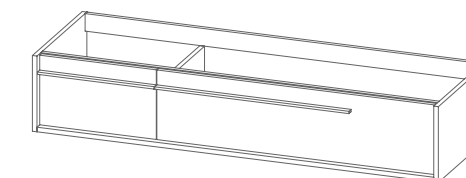

140 SD\_ sob consulta



obs:  
móvel 60/80/100/120S \_1 gaveta  
móvel 120SD \_2 gavetas  
móvel 120DD/140DD \_2 gavetas

Tampos - profundidade 45,5

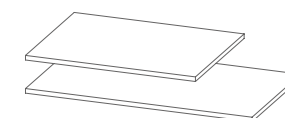

60\_ sob consulta  
80\_ sob consulta  
100\_ sob consulta  
120\_ sob consulta  
140\_ sob consulta

## Acabamentos

lacados . categoria 01

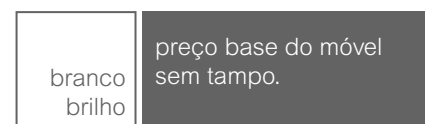

obs:  
os acabamentos folheados apenas são possíveis nas frentes e nas réguas dos móveis.  
neste modelo não é possível utilizar melaminas.

nota:  
possibilidade de combinar acabamentos, tendo em conta os respetivos acréscimos por cada categoria.

ex: corpo branco + frente lacado cor =  
= acréscimo categoria 2

lacados brilho / mate . categoria 02

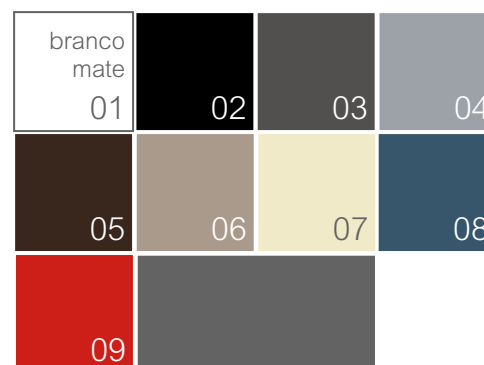

folheados . categoria 03

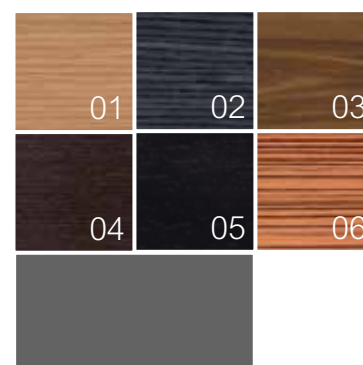

acabamentos pág. 076

Mais imagens  
do produto catálogo  
DESIGN COLLECTION pág. 80



kitbanho.com/sara

Manual técnico



KIT  
BANHO®

A estes preços acresce IVA à taxa em vigor.

## Acabamentos

lacados / melaminas . categoria 01



nota:  
possibilidade de combinar acabamentos, tendo em conta os respetivos acréscimos por cada categoria.

ex: corpo branco + frente folha =  
= acréscimo categoria 3

lacados brilho / mate . categoria 02

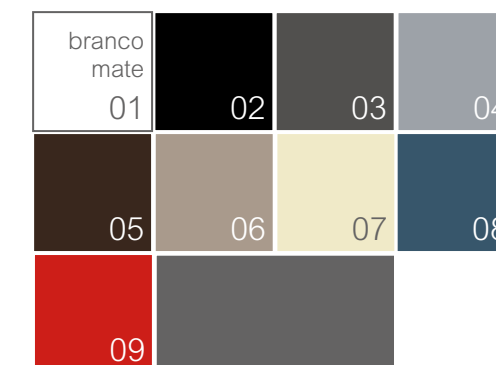

Mais imagens  
do produto catálogo  
DESIGN COLLECTION pág. 94



kitbanho.com/berna

Manual técnico



acabamentos pág. 076

A estes preços acresce IVA à taxa em vigor.

# modelo GRANADA

Alt. 26 - profundidade 45,5

preço base sem tampo

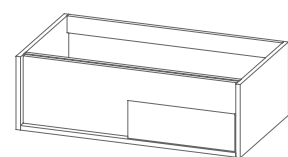

60 S\_ sob consulta  
80 S\_ sob consulta  
100 S\_ sob consulta  
120 S\_ sob consulta

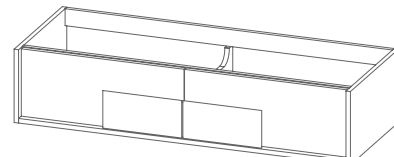

120 DD\_ sob consulta  
140 DD\_ sob consulta

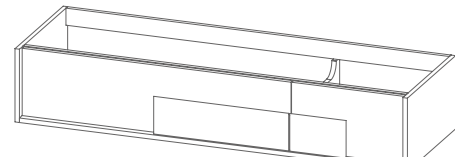

140 SD\_ sob consulta



obs:  
móvel 60/80/100/120S \_1 gaveta  
móvel 120SD \_2 gavetas  
móvel 120DD/140DD \_2 gavetas

Tampos - profundidade 45,5

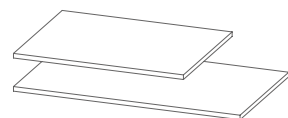

60\_ sob consulta  
80\_ sob consulta  
100\_ sob consulta  
120\_ sob consulta  
140\_ sob consulta

## Acabamentos

lacados / melaminas . categoria 01



nota:  
possibilidade de combinar acabamentos,  
tendo em conta os respetivos acréscimos  
por cada categoria.

ex: corpo branco + frente folha =  
= acréscimo categoria 3

lacados brilho / mate . categoria 02

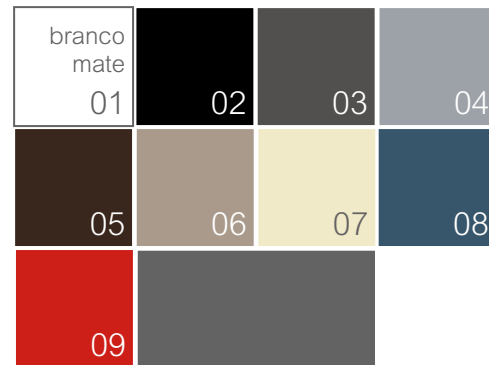

Mais imagens  
do produto catálogo  
DESIGN COLLECTION pág. 106



kitbanho.com/granada

Manual técnico



**KIT  
BANHO**

A estes preços acresce IVA à taxa em vigor.

# modelo DOMUS

Alt. 26 - profundidade 45,5

preço base sem tampo

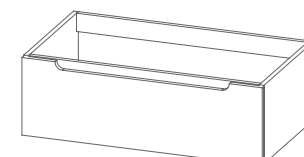

60 S\_ sob consulta  
80 S\_ sob consulta  
100 S\_ sob consulta  
120 S\_ sob consulta

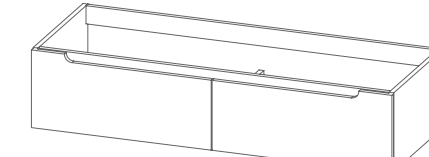

120 DD\_ sob consulta  
140 DD\_ sob consulta



obs:  
móvel 60/80/100/120S \_1 gaveta  
móvel 120DD/140DD \_2 gavetas

Tampos - profundidade 45,5

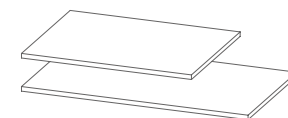

60\_ sob consulta  
80\_ sob consulta  
100\_ sob consulta  
120\_ sob consulta  
140\_ sob consulta

## Acabamentos

lacados . categoria 01

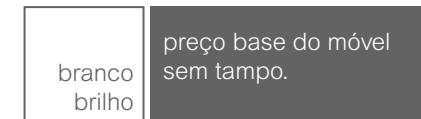

obs:  
neste modelo não é possível utilizar  
melaminas ou folheados.

nota:  
possibilidade de combinar acabamentos,  
tendo em conta os respetivos acréscimos  
por cada categoria.

ex: corpo branco + frente lacado cor =  
= acréscimo categoria 2

lacados brilho / mate . categoria 02

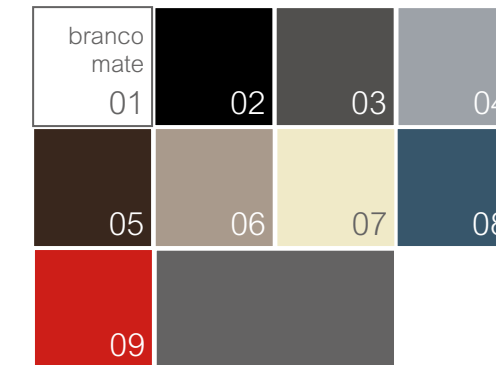

Mais imagens  
do produto catálogo  
DESIGN COLLECTION pág. 117



kitbanho.com/domus

Manual técnico



A estes preços acresce IVA à taxa em vigor.

# modelo POMPEIA

Alt. 26 - profundidade 45,5

preço base sem tampo

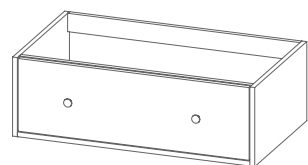

60 S\_ sob consulta  
80 S\_ sob consulta  
100 S\_ sob consulta  
120 S\_ sob consulta

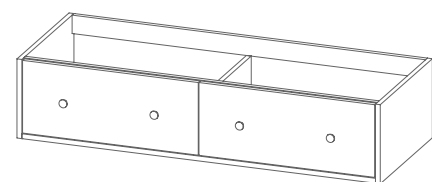

120 DD\_ sob consulta  
140 DD\_ sob consulta

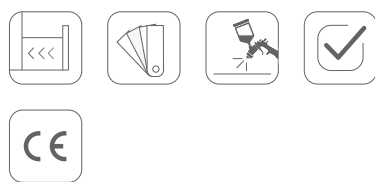

obs:  
móvel 60/80/100/120S \_1 gaveta  
móvel 120DD/140DD \_2 gavetas

Tampos - profundidade 45,5

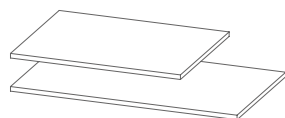

60\_ sob consulta  
80\_ sob consulta  
100\_ sob consulta  
120\_ sob consulta  
140\_ sob consulta

# modelo LIÈGE

Alt. 26 - profundidade 45,5

preço base sem tampo

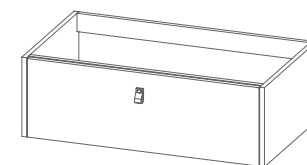

60 S\_ sob consulta  
80 S\_ sob consulta  
100 S\_ sob consulta  
120 S\_ sob consulta

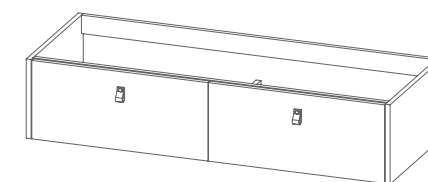

120 DD\_ sob consulta  
140 DD\_ sob consulta

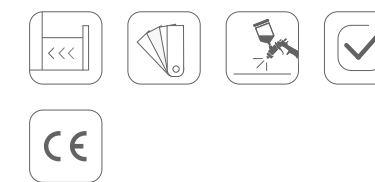

obs:  
móvel 60/80/100/120S \_1 gaveta  
móvel 120DD/140DD \_2 gavetas

Tampos - profundidade 45,5

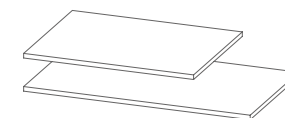

60\_ sob consulta  
80\_ sob consulta  
100\_ sob consulta  
120\_ sob consulta  
140\_ sob consulta

## Acabamentos

lacados / melaminas . categoria 01

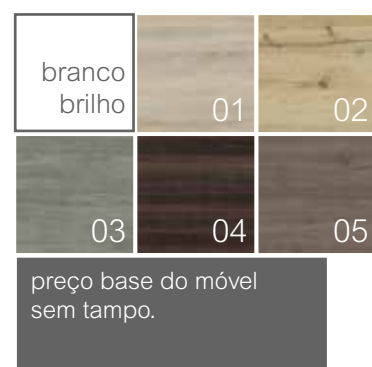

lacados brilho / mate . categoria 02

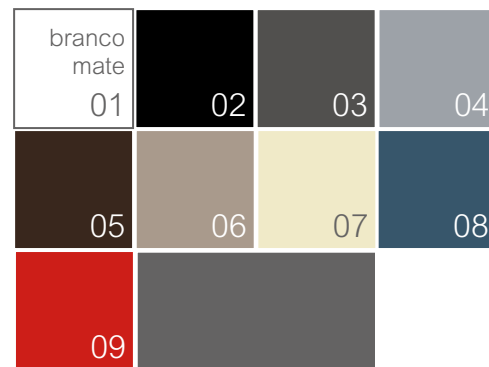

folheados . categoria 03

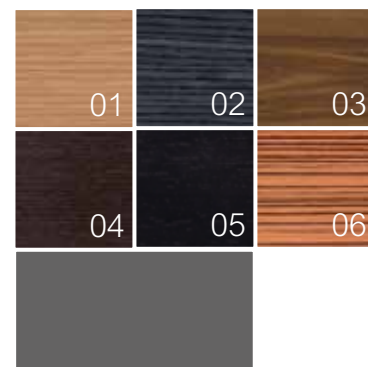

nota:  
possibilidade de combinar acabamentos,  
tendo em conta os respetivos acréscimos  
por cada categoria.

ex: corpo branco + frente folha =  
= acréscimo categoria 3

Mais imagens  
do produto catálogo  
DESIGN COLLECTION pág. 134



kitbanho.com/pompeia

Manual técnico



KIT  
BANHO®

A estes preços acresce IVA à taxa em vigor.

## Acabamentos

lacados / melaminas . categoria 01



lacados brilho / mate . categoria 02

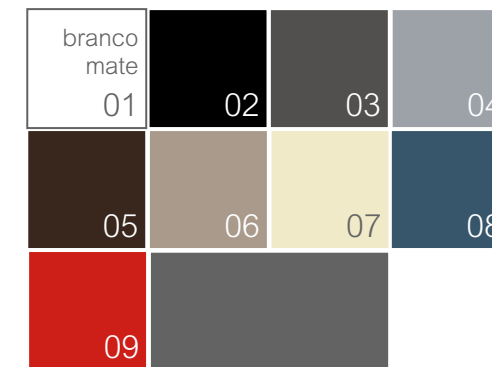

folheados . categoria 03

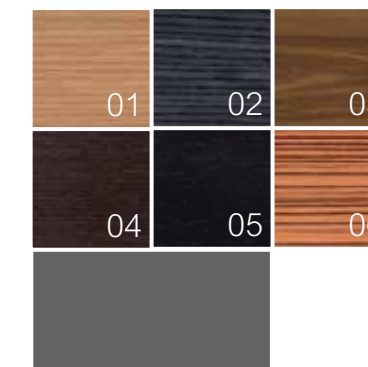

nota:  
possibilidade de combinar acabamentos,  
tendo em conta os respetivos acréscimos  
por cada categoria.

ex: corpo branco + frente folha =  
= acréscimo categoria 3

Mais imagens  
do produto catálogo  
DESIGN COLLECTION pág. 156



kitbanho.com/liege

Manual técnico



A estes preços acresce IVA à taxa em vigor.

# modelo HAIA

Alt. 26 - profundidade 45,5

preço base com tampo

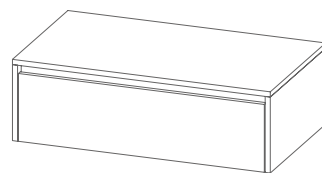

obs:  
móvel 60/80/100 \_1 gaveta

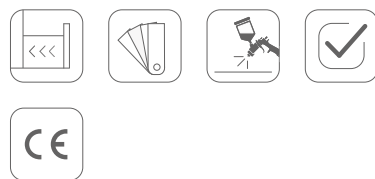

60\_ sob consulta  
80\_ sob consulta  
100\_ sob consulta

Mais imagens  
do produto catálogo  
SOLUÇÕES ECONÓMICAS pág. 04

## Acabamentos

lacados / melaminas . categoria 01

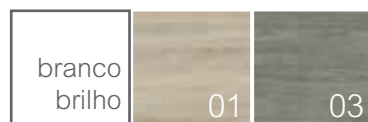

preço base do móvel  
com tampo.

nota:  
apenas possível nos acabamentos  
apresentados.

acabamentos pág. 076

## exemplo de combinações

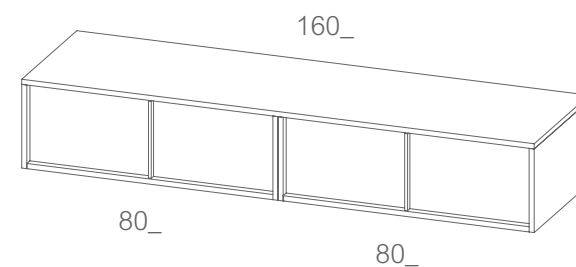

ancara alt.26 80 S

ancara alt.26 80 S

tampo 160

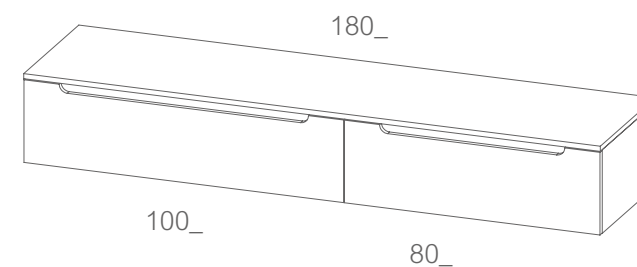

domus alt.26 100 S

domus alt.26 80 S

tampo 180

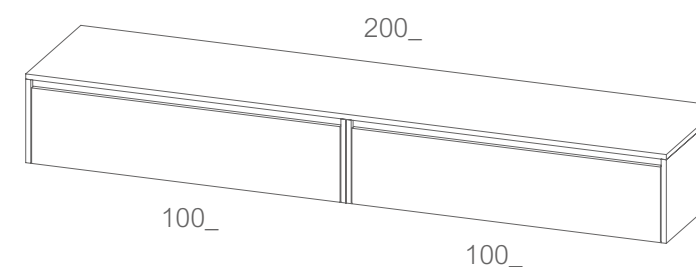

odessa alt.26 100 S

odessa alt.26 100 S

tampo 200

## Tamos - profundidade 45,5

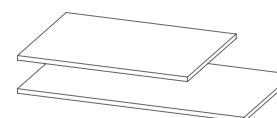

60\_ sob consulta  
80\_ sob consulta  
100\_ sob consulta  
120\_ sob consulta  
140\_ sob consulta

160\_ sob consulta  
180\_ sob consulta  
200\_ sob consulta

observação:  
tamos lacados em mdf hidrófugo.  
tamos fornecidos sem furação para lavatório de posar.



estrutura  
**KLOSS STD**

KIT  
BA  
NHO® | **KLOSS®**



\_ estrutura KLOSS STD , preto  
\_ gaveta KLOSS STD , branco  
\_ espelho pompeia

KIT  
BA  
NHO® | **KLOSS®**



\_ estrutura KLOSS STD , preto  
\_ prateleira KLOSS STD , branco  
\_ espelho ancara , branco

KIT  
BANHO®  
**KLOSS®**



## estrutura KLOSS STD

Alt. 85 - profundidade 45,5

preço base sem gaveta / prateleira

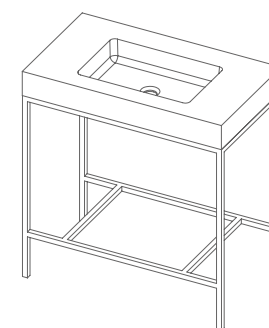

80 S\_ sob consulta  
100 S\_ sob consulta  
120 S\_ sob consulta  
140 S\_ sob consulta

obs:  
lav. 80 \_cuba 45  
lav. 100/120/140 \_cuba 55

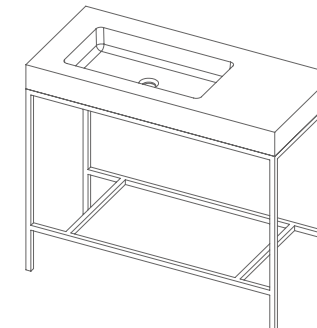

100 SE\_ sob consulta  
120 SE\_ sob consulta  
140 SE\_ sob consulta

obs:  
lav. 100/120/140 \_cuba 55

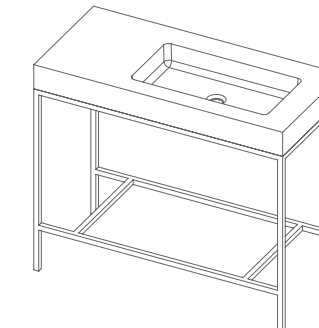

100 SD\_ sob consulta  
120 SD\_ sob consulta  
140 SD\_ sob consulta

obs:  
lav. 100/120/140 \_cuba 55

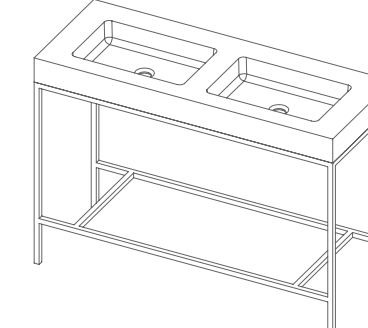

120 D\_ sob consulta  
140 D\_ sob consulta

obs:  
lav. 120/140 \_cuba 45

acabamentos lavatórios:  
- branco brilho / branco mate

acabamentos estruturas:  
- branco mate / preto mate

obs.:  
- todos as lavatórios têm a possibilidade de ter furo para a torneira.  
- não é possível alterar medidas técnicas dos lavatórios, nem posição das cubas.  
- **stock permanente.**

## gaveta KLOSS STD

Alt. 18 - profundidade 45,5

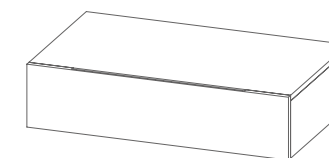

80 S\_ sob consulta  
100 S\_ sob consulta  
120 S\_ sob consulta  
120 D\_ sob consulta  
140 D\_ sob consulta

acabamentos:  
lacado branco brilho\_ preço base.  
melaminas\_ preço base.  
lacados mate / brilho  
folheados

obs.:  
Simple - 1 gaveta  
Duplo - 2 gavetas

## prateleira KLOSS STD

Alt. 1,6 - profundidade 45,5

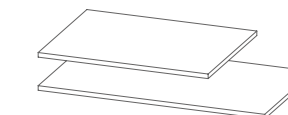

80\_ sob consulta  
100\_ sob consulta  
120\_ sob consulta  
140\_ sob consulta

acabamentos:  
lacado branco brilho\_ preço base.  
melaminas\_ preço base.  
lacados mate / brilho  
folheados

Manual técnico



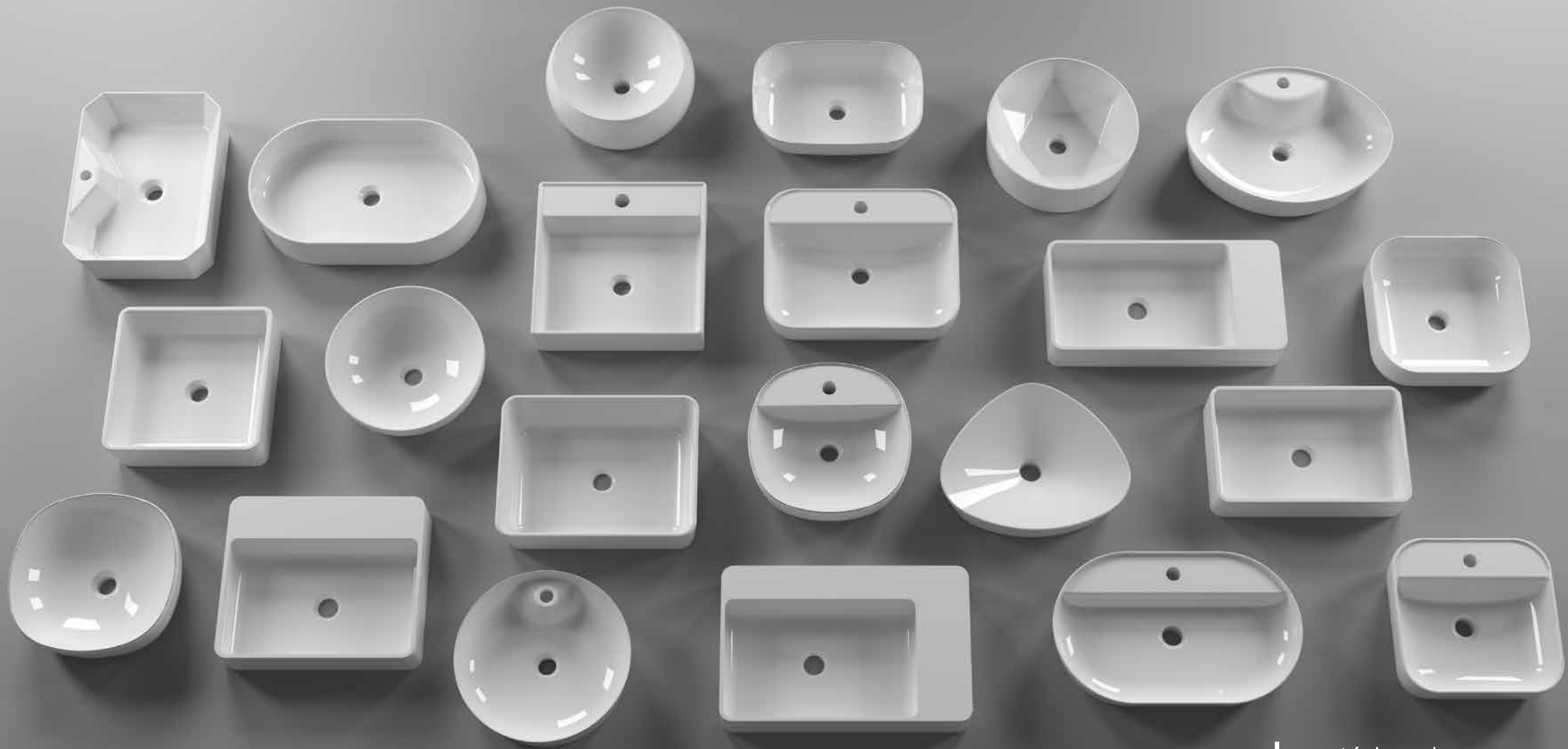

Lavatórios de pousar





lav. pousar\_ TURIM cerâmico

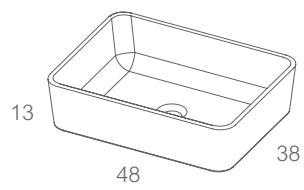

ref. 001\_ sob consulta

Medidas técnicas



A estes preços acresce IVA à taxa em vigor.

lav. pousar\_ BERNA

cerâmico

ref. 002\_ sob consulta

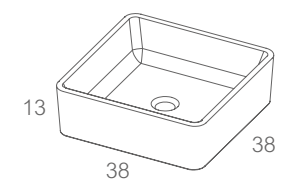

Medidas técnicas



**KIT  
BA  
NHO**



lav. pousar\_ZAMORA

cerâmico

ref. 003\_ sob consulta

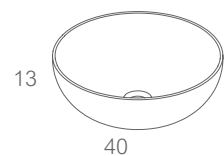

Medidas técnicas



lav. pousar\_ALBA

cerâmico

ref. 004\_ sob consulta

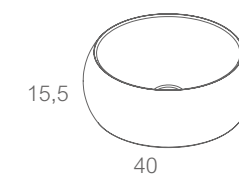

Medidas técnicas



**KIT  
BA  
NHO**®

A estes preços acresce IVA à taxa em vigor.

A estes preços acresce IVA à taxa em vigor.





052



lav. pousar\_ZADAR

cerâmico

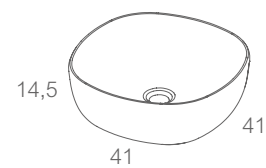

ref. 005\_ sob consulta

Medidas técnicas



lav. pousar\_OSLO

cerâmico

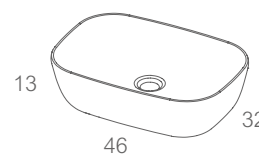

ref. 006\_ sob consulta

Medidas técnicas



053



**KIT  
BANHO**<sup>®</sup>

A estes preços acresce IVA à taxa em vigor.





054

lav. pousar\_ ZURIQUE

cerâmico

ref. 007\_ sob consulta

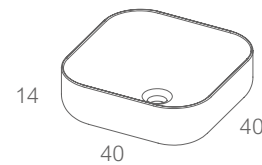

Medidas técnicas



A estes preços acresce IVA à taxa em vigor.

lav. pousar\_ PRAGA

cerâmico

ref. 008\_ sob consulta

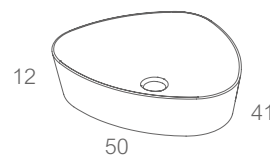

Medidas técnicas



**KIT  
BA  
NHO**<sup>®</sup>



056



057



lav. pousar\_ HANNOVER

cerâmico

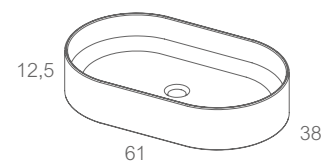

ref. 009\_ sob consulta

Medidas técnicas



lav. pousar\_ PALMA

cerâmico

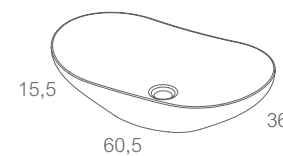

ref. 010\_ sob consulta

Medidas técnicas



**KIT  
BANHO**<sup>®</sup>

A estes preços acresce IVA à taxa em vigor.







058



lav. pousar\_ ASTRO

cerâmico

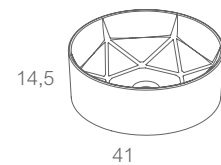

ref. 011\_ sob consulta

Medidas técnicas



**KIT  
BANHO**



059

lav. pousar\_ CALAMA

cerâmico

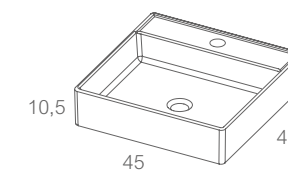

ref. 012\_ sob consulta

Medidas técnicas



A estes preços acresce IVA à taxa em vigor.

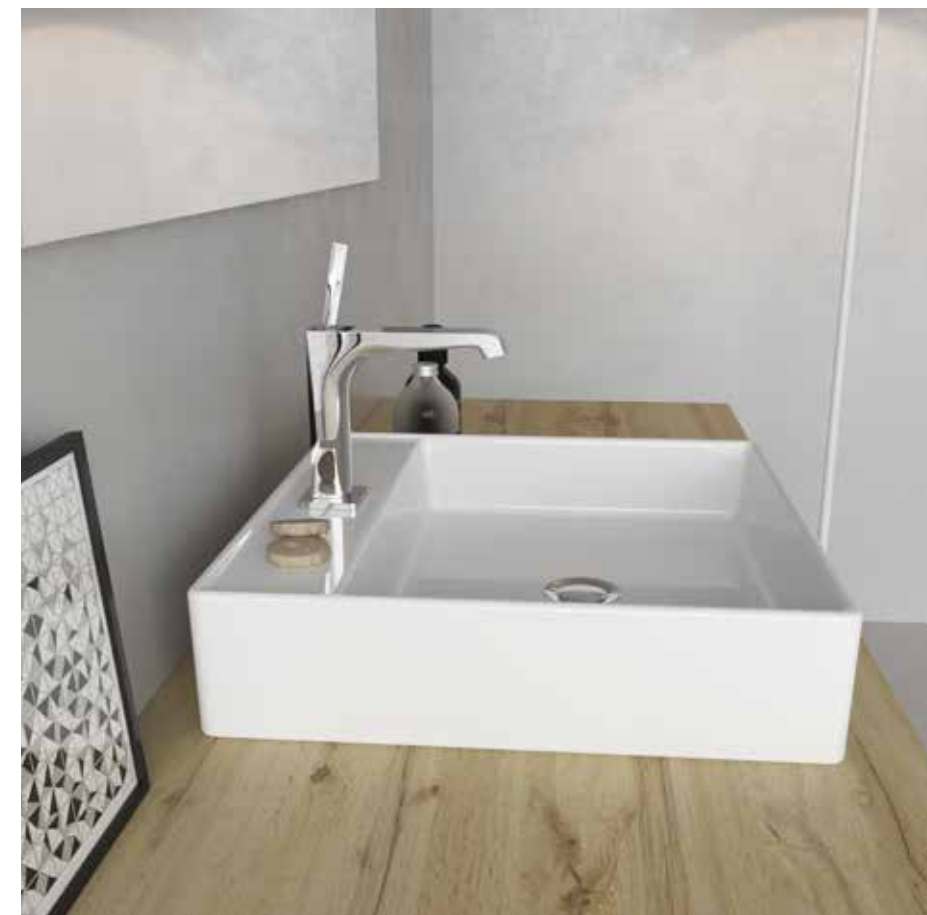





060

lav. pousar\_ HAIA

cerâmico

ref. 013\_ sob consulta

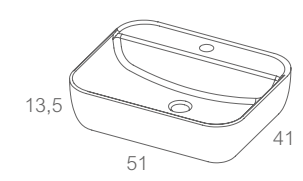

Medidas técnicas



A estes preços acresce IVA à taxa em vigor.



lav. pousar\_ DUBLIN

cerâmico

ref. 014\_ sob consulta

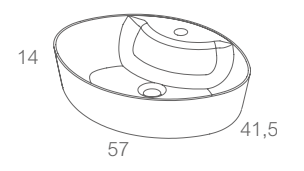

Medidas técnicas



**KIT  
BA  
NHO**<sup>®</sup>



061





lav. pousar\_ FLORENÇA cerâmico

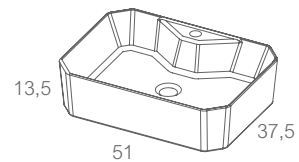

ref. 015\_ sob consulta

Medidas técnicas



lav. pousar\_ COLOMBO cerâmico

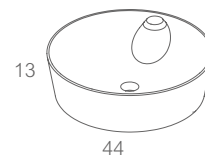

ref. 016\_ sob consulta

Medidas técnicas







lav. pousar\_ NICE

cerâmico

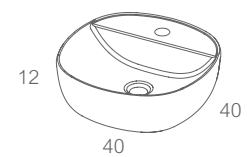

ref. 017\_ sob consulta

Medidas técnicas



lav. pousar\_ COLÓNIA

cerâmico

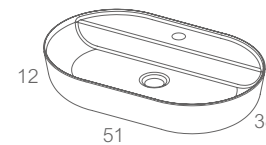

ref. 018\_ sob consulta

Medidas técnicas



**KIT  
BA  
NHO**®





lav. pousar\_ VIENA

cerâmico

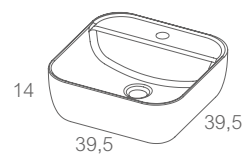

ref. 019\_ sob consulta

Medidas técnicas



**KIT  
BANHO®**

A estes preços acresce IVA à taxa em vigor.



lav. pousar\_ NATURAL

KLOSS

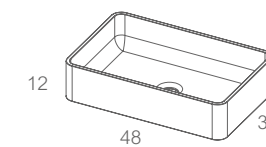

ref. 020\_ sob consulta

acabamentos:  
- branco brilho / branco mate

Medidas técnicas







068



069



lav. pousar\_ SHIP

KLOSS

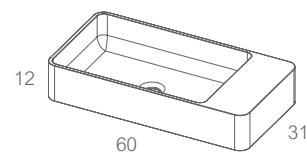

ref. 021\_ sob consulta

acabamentos:  
- branco brilho / branco mate

obs.:  
- possibilidade de ter furo para a torneira.

Medidas técnicas



A estes preços acresce IVA à taxa em vigor.

lav. pousar\_ TABLE

KLOSS

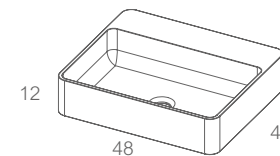

ref. 022\_ sob consulta

acabamentos:  
- branco brilho / branco mate

obs.:  
- possibilidade de ter furo para a torneira.

Medidas técnicas



A estes preços acresce IVA à taxa em vigor.

**KIT  
BANHO**





070

lav. pousar\_ BOOK

KLOSS

ref. 023\_ sob consulta

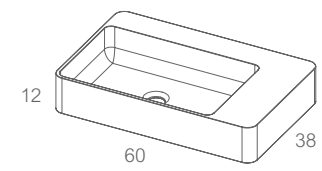

Medidas técnicas



acabamentos:  
- branco brilho / branco mate

obs.:  
- possibilidade de ter furo para a torneira.

A estes preços acresce IVA à taxa em vigor.





072



073

## Tamos p/ lav. pousar

Alt. 1,6 - prof. 45,5

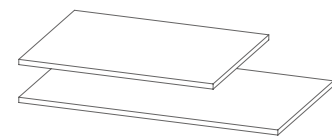

60\_ sob consulta  
80\_ sob consulta  
100\_ sob consulta  
120\_ sob consulta  
140\_ sob consulta

acabamentos:

lacado branco brilho\_  
melaminas\_  
lacados mate / brilho\_  
folheados\_

obs.:  
tamos lacados em mdf hidrófugo.  
tamos fornecidos sem furação para lavatório de pousar.

## Tamos laterais

Alt. 1,6 - prof. 45,5

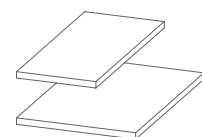

20\_ sob consulta  
30\_ sob consulta  
40\_ sob consulta  
50\_ sob consulta  
70\_ sob consulta

acabamentos:

lacado branco brilho\_  
melaminas\_  
lacados mate / brilho\_  
folheados\_

obs.:  
tamos lacados em mdf hidrófugo.

## Tamos de vidro

Alt. 0,8 - prof. 45,5

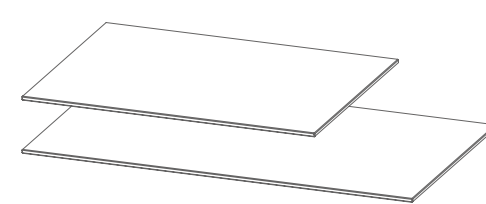

20\_ sob consulta  
30\_ sob consulta  
40\_ sob consulta  
50\_ sob consulta  
70\_ sob consulta

60\_ sob consulta  
80\_ sob consulta  
100\_ sob consulta  
120S\_ sob consulta  
120D\_ sob consulta  
140S\_ sob consulta  
140D\_ sob consulta

acabamentos: TRANSPARENTE

obs.: tamos de 60 até 140 c/ furação para lavatório de pousar.

20\_ sob consulta  
30\_ sob consulta  
40\_ sob consulta  
50\_ sob consulta  
70\_ sob consulta

60\_ sob consulta  
80\_ sob consulta  
100\_ sob consulta  
120S\_ sob consulta  
120D\_ sob consulta  
140S\_ sob consulta  
140D\_ sob consulta

acabamentos: BRANCO VEC

obs.: tamos de 60 até 140 c/ furação para lavatório de pousar.

**KIT  
BANHO**<sup>®</sup>



074

## Tamos KLOSS

Alt. 2 - prof. 45,5

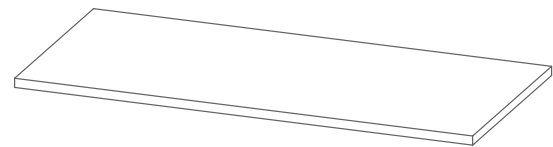

60\_ sob consulta  
80\_ sob consulta  
100\_ sob consulta  
120\_ sob consulta  
140\_ sob consulta

acabamentos:  
- branco brilho / branco mate

obs.:  
- tamos em KLOSS.  
- tamos fornecidos sem furação.  
- **stock permanente (excepto cantos arredondados).**



A estes preços acresce IVA à taxa em vigor.



075

## Tamos KLOSS c/ toalheiro

Alt. 2 - prof. 45,5

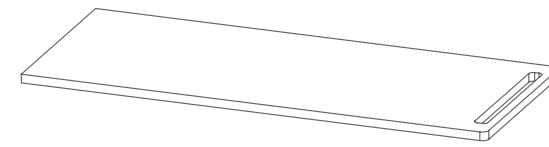

60\_ sob consulta  
80\_ sob consulta  
100\_ sob consulta  
120\_ sob consulta  
140\_ sob consulta

acabamentos:  
- branco brilho / branco mate

obs.:  
- tamos em KLOSS.  
- toalheiro reversível (direito/esquerdo).  
- tamos fornecidos sem furação.  
- **stock permanente.**



Medidas técnicas



**KIT  
BANHO**

A estes preços acresce IVA à taxa em vigor.



# acabamentos MELAMINAS



# acabamentos LACADOS



Mais imagens dos acabamentos



Mais imagens dos acabamentos



**KIT  
BANHO®**

**KIT  
BANHO®**



# acabamentos FOLHEADOS



carvalho 01



carvalho cinza 02



nogueira 03



panga 04



wengue 05



zebrano 06

# simbologia

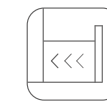

gavetas soft-close

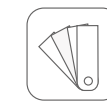

cores ral

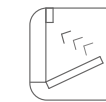

portas soft-close



anti-embaciamento



lacados



qualidade controlada



certificado europeu



iluminação led

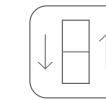

coluna reversível



cromado



material em MDF hidrófugo

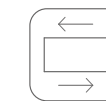

espelho reversível



índice de proteção

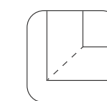

corte em 45°

# marcas

madeiras / melaminas:



gavetas / dobradiças:



gaveta NOVA PRO DELUXE 350

dobradiça TIOMOS SOFT



## CONDIÇÕES GERAIS DE VENDA

Os preços aqui apresentados podem ser alterados sem aviso prévio.  
A estes preços acresce IVA à taxa em vigor.

### REALIZAÇÃO DE ENCOMENDAS

As encomendas têm obrigatoriamente que ser realizadas via e-mail, não são aceites encomendas por chamada telefónica.

### RECLAMAÇÕES

Todas as reclamações devem ser efetuadas no prazo máximo de 15 dias após a entrega da mercadoria, exceto espelhos e lavatórios cuja reclamação deve constar nos documentos de entrega.

### DEVOLUÇÕES

Não se aceitam devoluções que não tenham sido previamente analisadas e autorizadas, pela empresa.  
Mercadoria personalizada não pode em caso algum ser devolvida, assim como material que tenha sido instalado.  
Em caso de devolução os produtos devem estar devidamente acondicionados e protegidos na sua embalagem original.

### FATURAÇÃO

Pagamentos até 8 dias: Desconto financeiro de 4% sobre o valor líquido da fatura.  
Pagamentos até 15 dias: Desconto financeiro de 2% sobre o valor líquido da fatura.  
Mais de 15 dias: sem desconto.  
(Os prazos indicados são considerados a partir da data da fatura)  
Não serão aceites quaisquer outros descontos financeiros.

### ANULAÇÃO OU ALTERAÇÃO DE ENCOMENDAS

As encomendas aceites não poderão ser anuladas ou alteradas nos seguintes casos:  
-Quando tiverem transcorrido 2 dias a partir da sua receção.  
-Quando se tiver efetuado a expedição do produto.  
-Quando se tenha iniciado o processo de fabricação especial para produtos especiais, ou seja, produtos não constantes nos nossos catálogos.

### PRAZOS DE ENTREGA

A falta de cumprimento do prazo de entrega não será motivo de reclamação por parte do Cliente, não podendo, em caso algum, dar origem a qualquer indemnização.  
Os atrasos de entrega originados por motivo de força maior ou que não sejam diretamente imputáveis à empresa, não serão causa justificativa para anulação da encomenda, por parte do cliente.

### GARANTIA

Os nossos produtos sempre que utilizados e instalados de forma correta, estão garantidos contra defeitos de fabrico por um período de 24 meses (2 anos).  
Para a aplicação desta garantia será necessário, em qualquer caso, a aceitação do defeito pelos nossos serviços técnicos e a devolução dos produtos defeituosos.  
Os gastos de transporte e embalagem que sejam originados pela assistência em garantia, são por conta da empresa.  
A garantia cobre apenas as falhas de operação resultantes de defeitos de fabrico.  
A garantia somente compromete o fabricante a reparar e/ou substituir componentes defeituosos.  
A garantia é anulada se:  
-A instalação não atende as instruções de instalação fornecidas pelo fabricante;  
-O defeito operacional resulta de adulteração ou intervenção não autorizada pelo fabricante;  
-O mau funcionamento é causado pelo desgaste anormal dos componentes devido a negligência no uso e manutenção indevida.

**KIT  
BA  
NHO®**

**KIT  
BA  
NHO®**

Catálogo KLOSS

Maio 2020

Zona Industrial de Talhadas,  
Sever do Vouga, Aveiro, Portugal  
geral@kitbanho.com  
tel. 234 560 430  
www.kitbanho.com

KIT  
BANHO<sup>®</sup>

[www.kitbanho.com](http://www.kitbanho.com)